

SINGER

143W2

71w
53)
in U.S.A.

SINGER**

143w2

THE SINGER COMPANY

**A Trade Mark of THE SINGER COMPANY

From the library of: Diamond Needle Corp

22443 22444 22442

241396

241404

241403

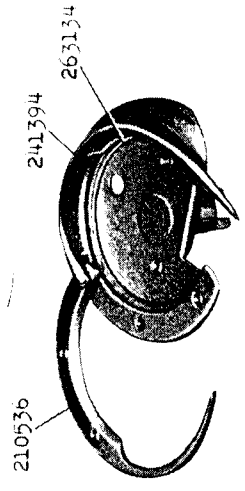

210914

210734

210913

2009640

2009620

2010163-0

210735

2-1-02

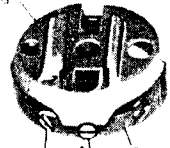

210736

2009667

A A A

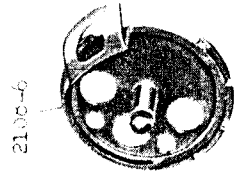

263054

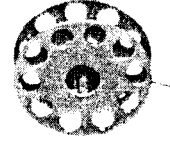

15974 - 3/8

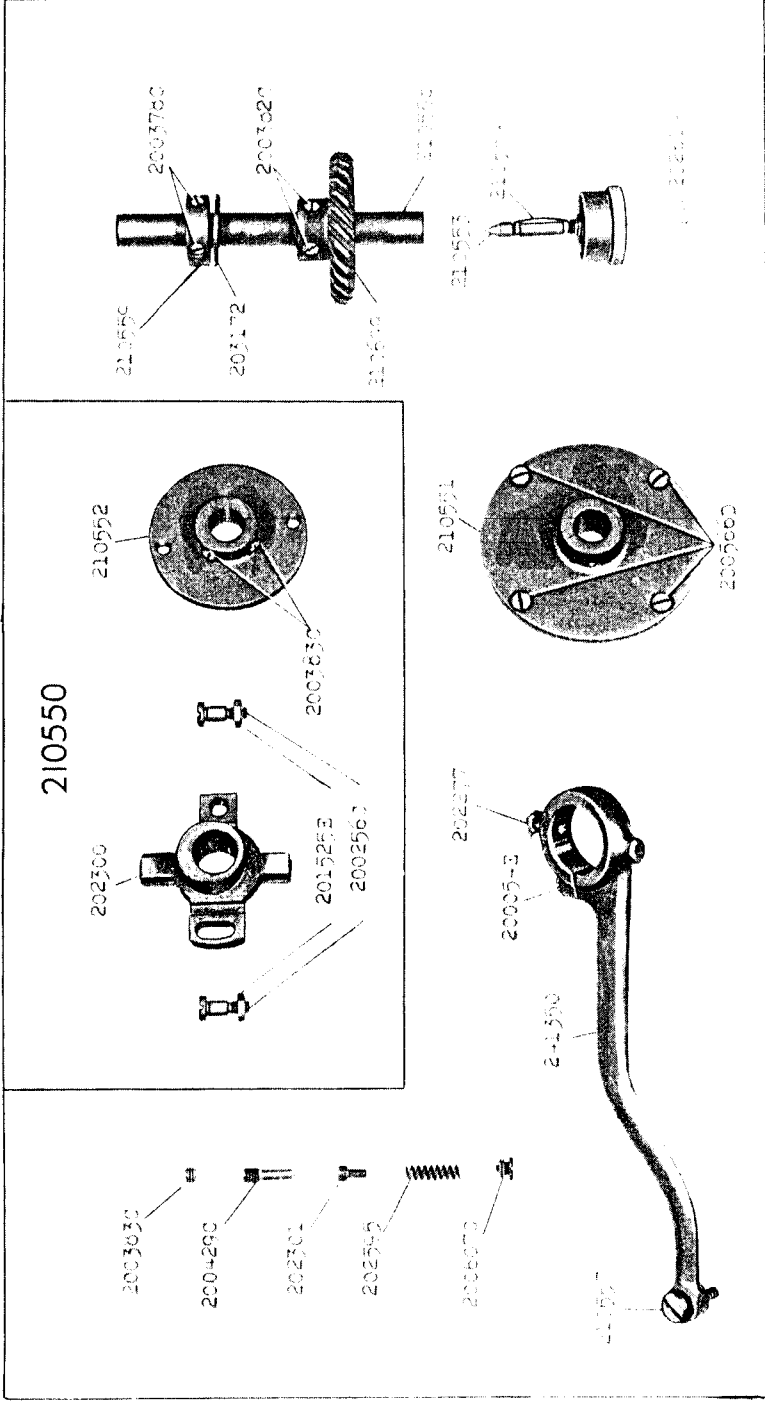

15979 - 1/2

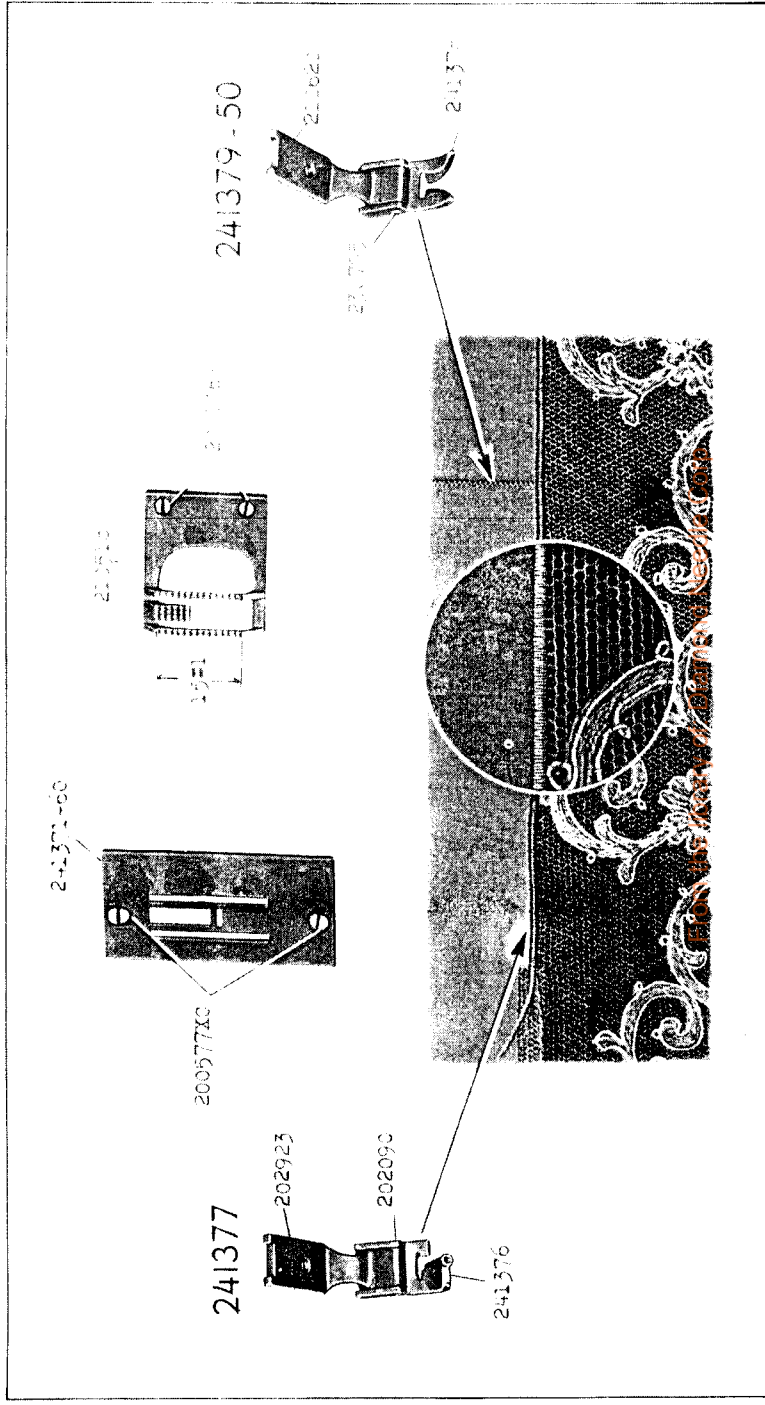

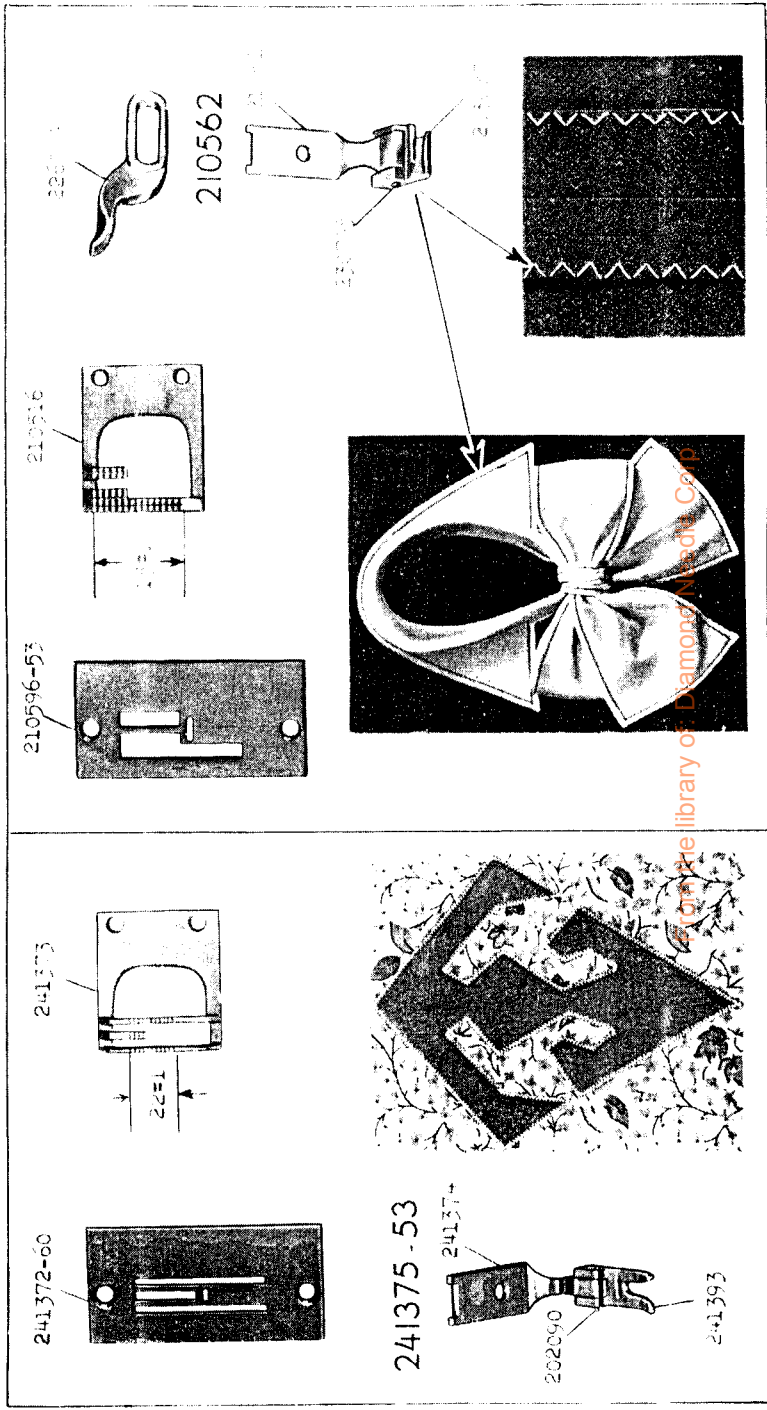
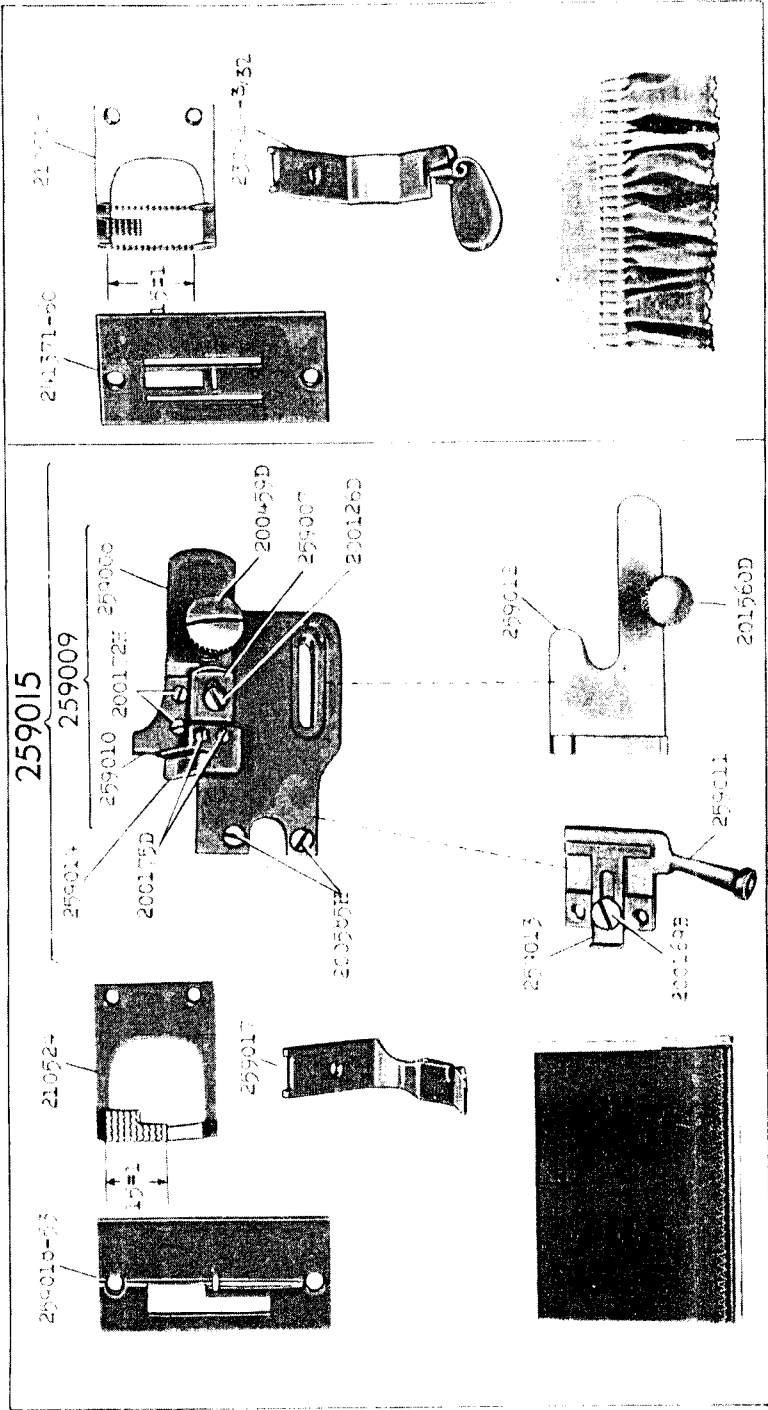

© The Library of Diamond Needle Corp

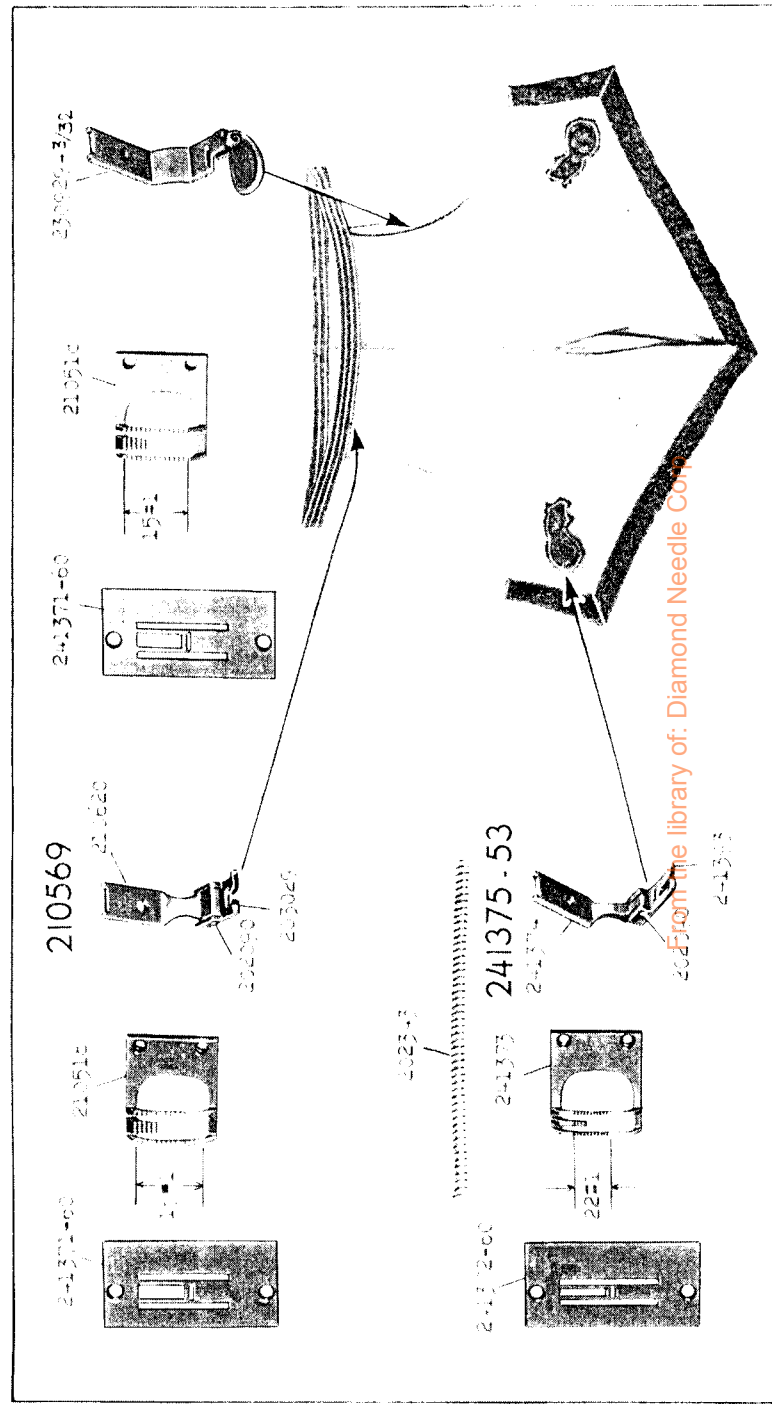
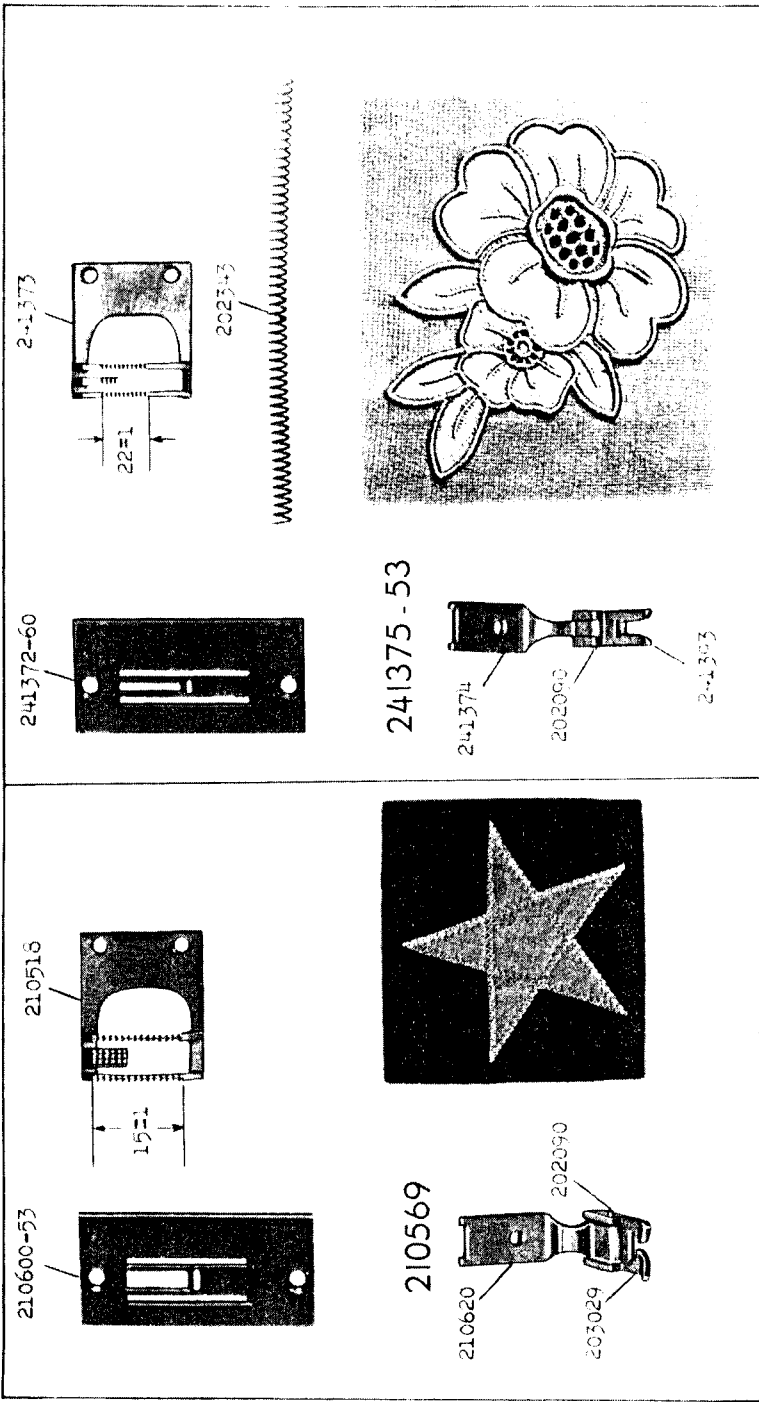

15998 - 3/8

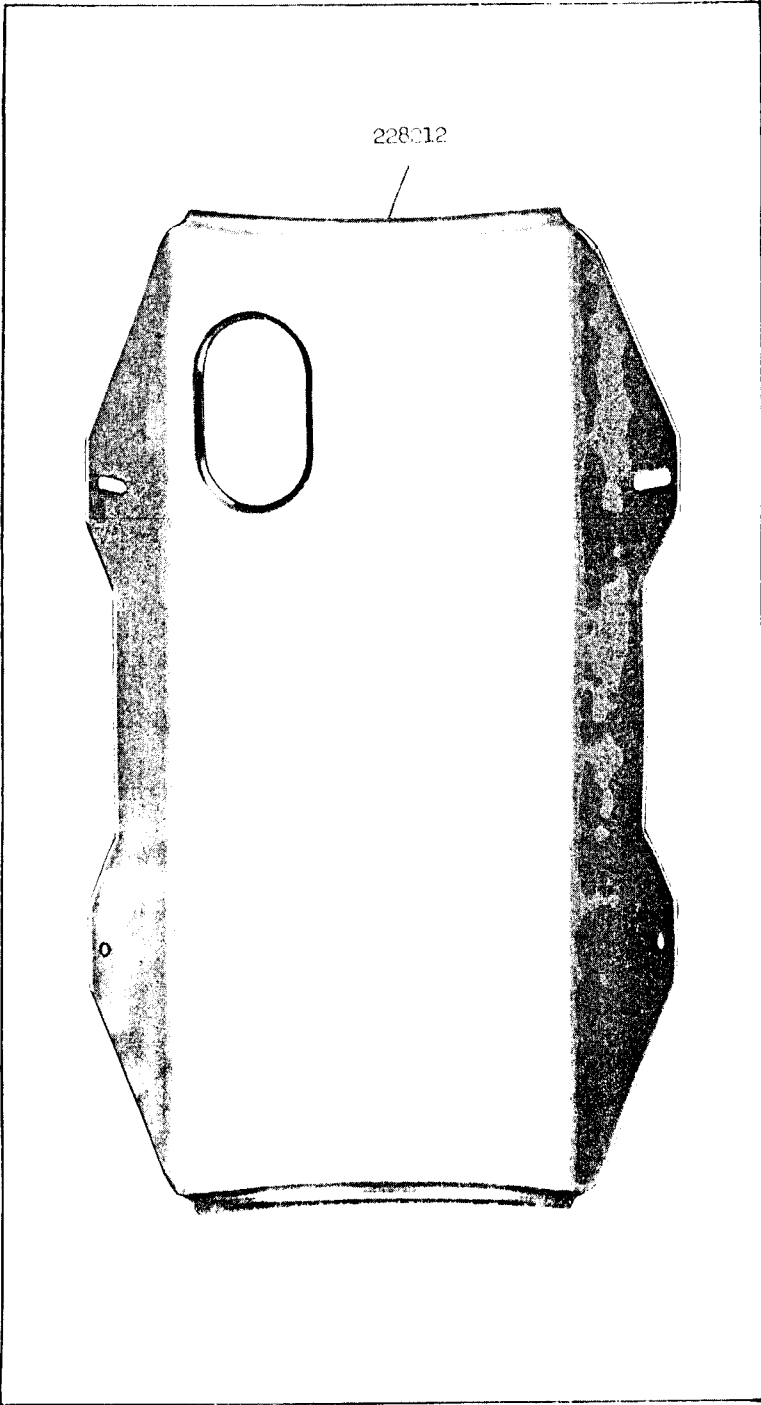

15999 - 3/8

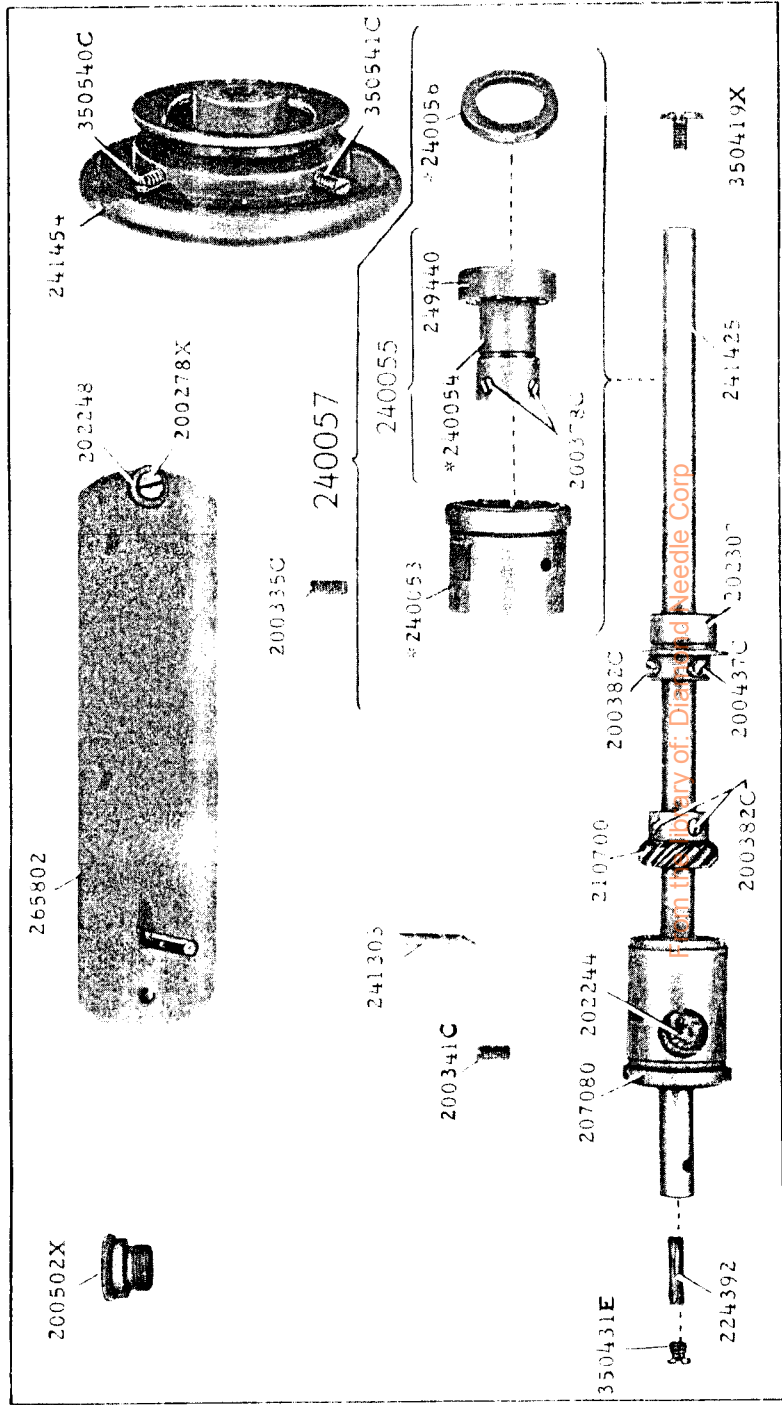

16002 - 1/2

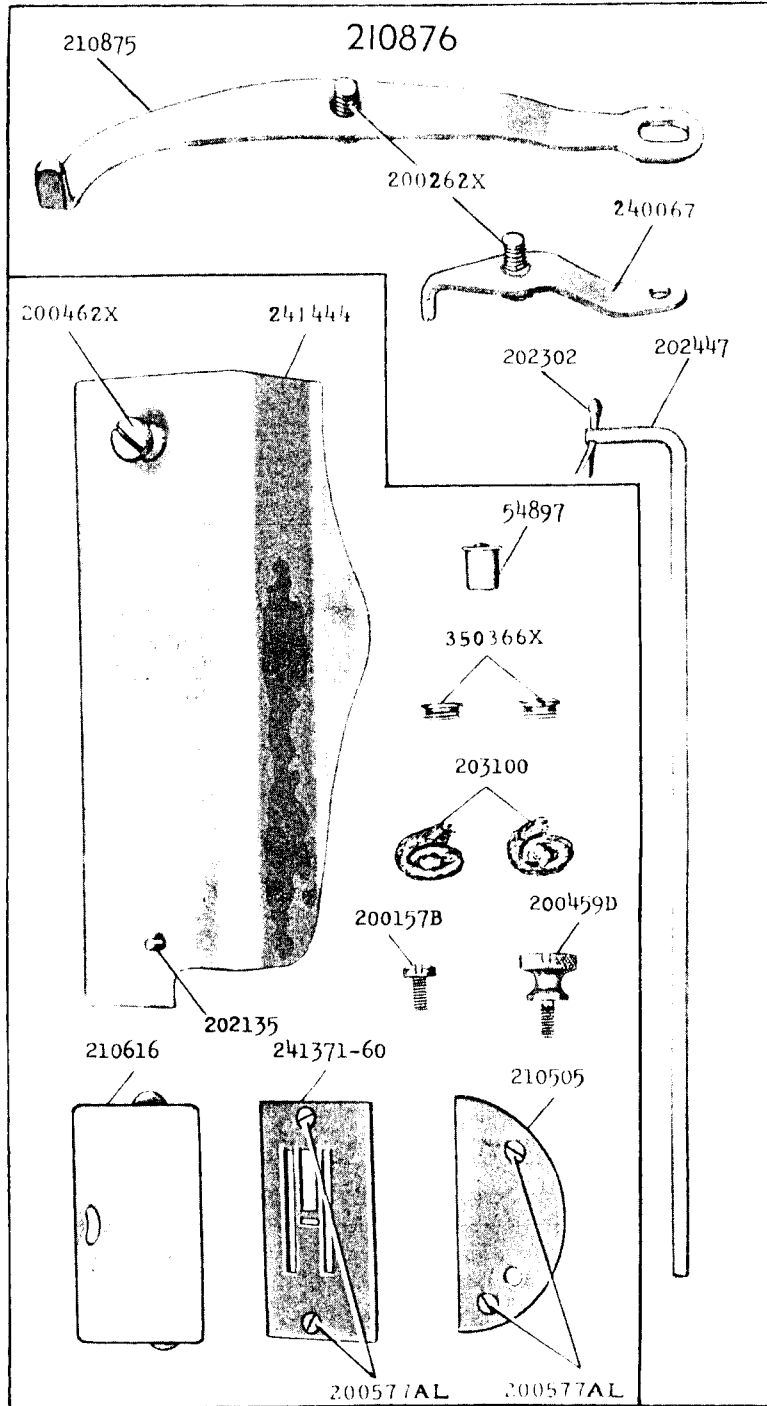

16003 - 1/2

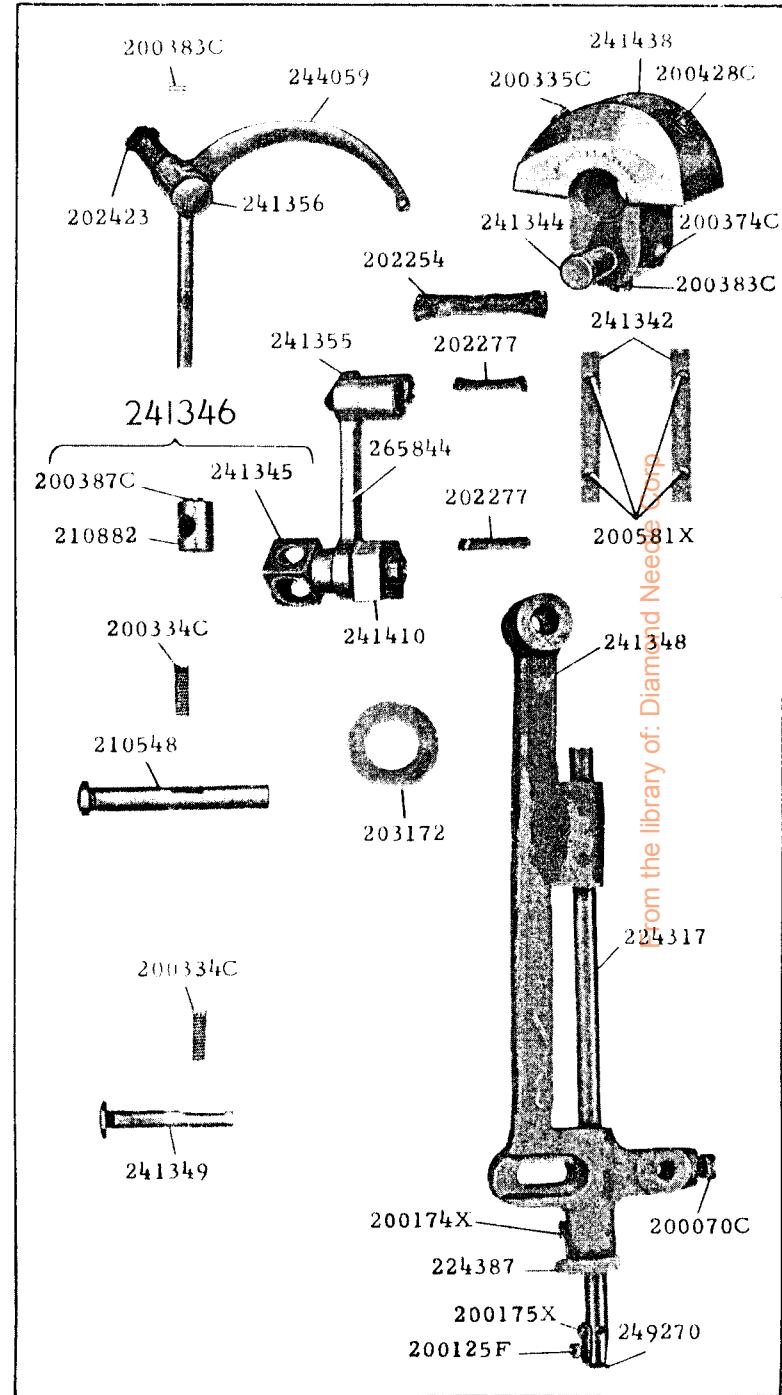

From the library of: Diamond Needs

16004 - 1/2

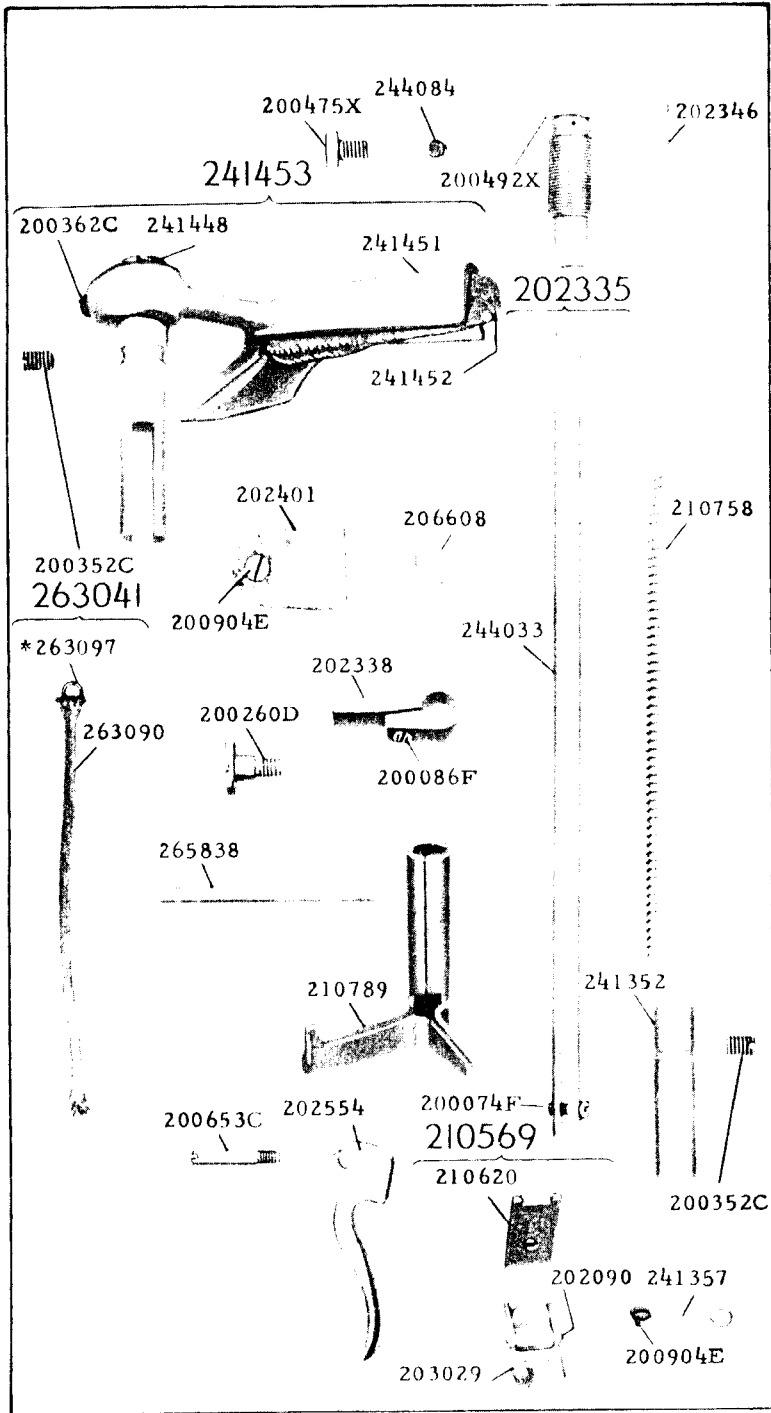

16005 - 3/4

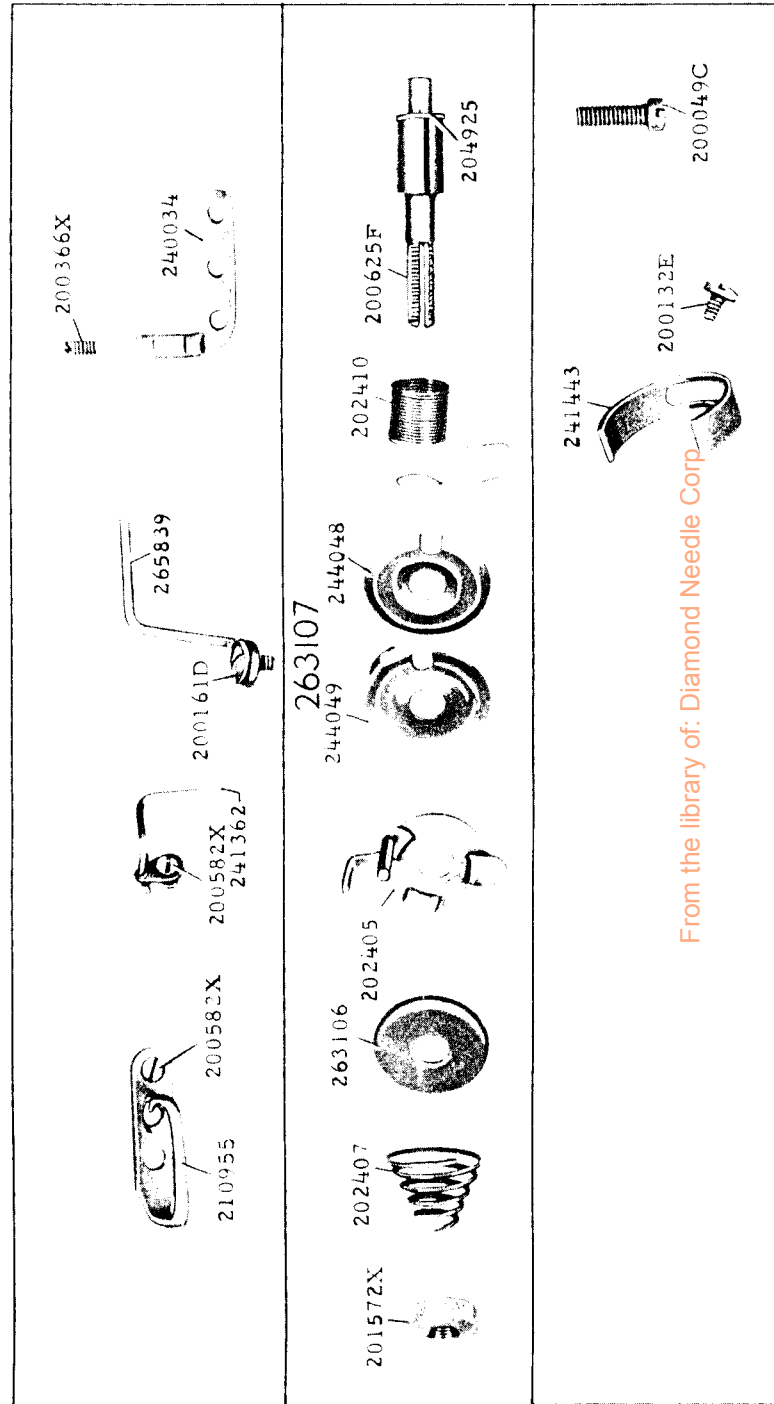

16006 - 1/2

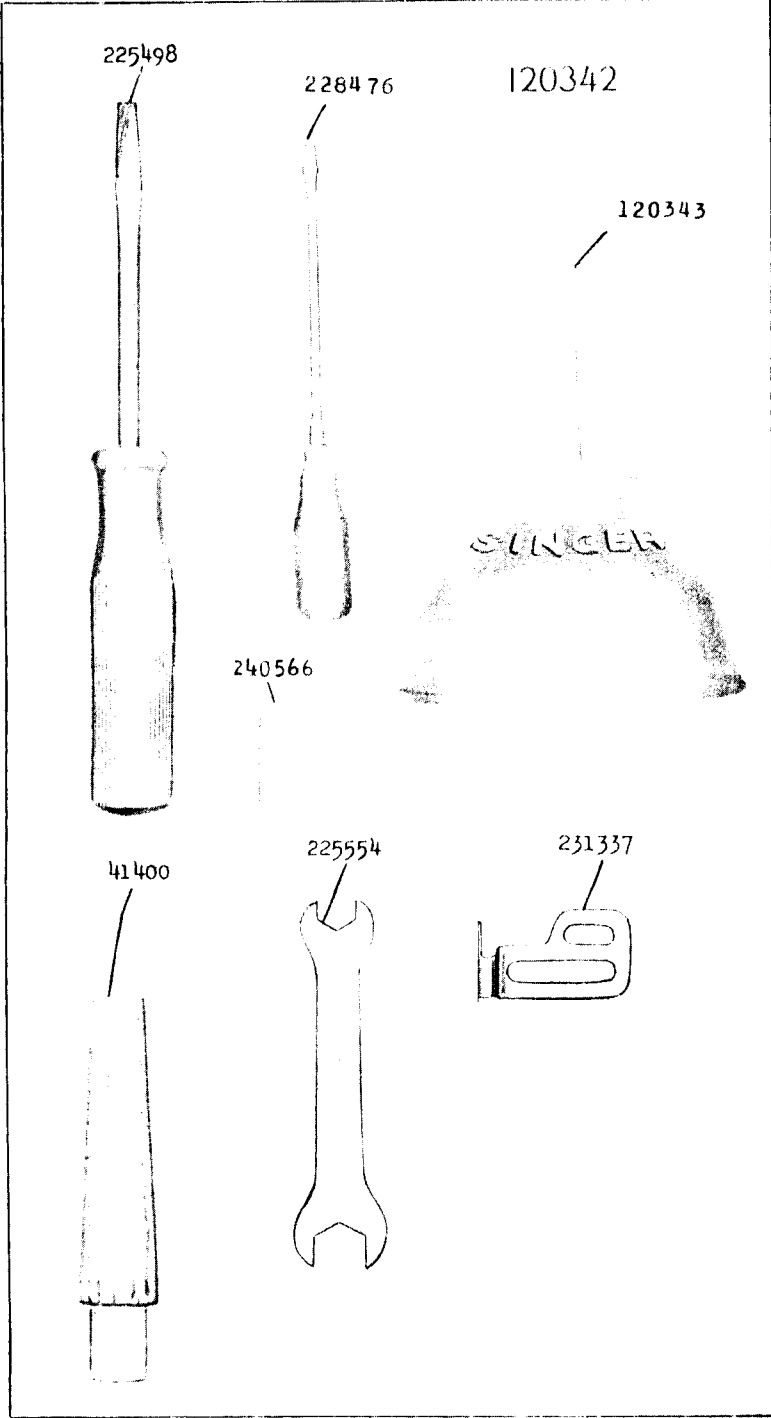

16007 - 3/8

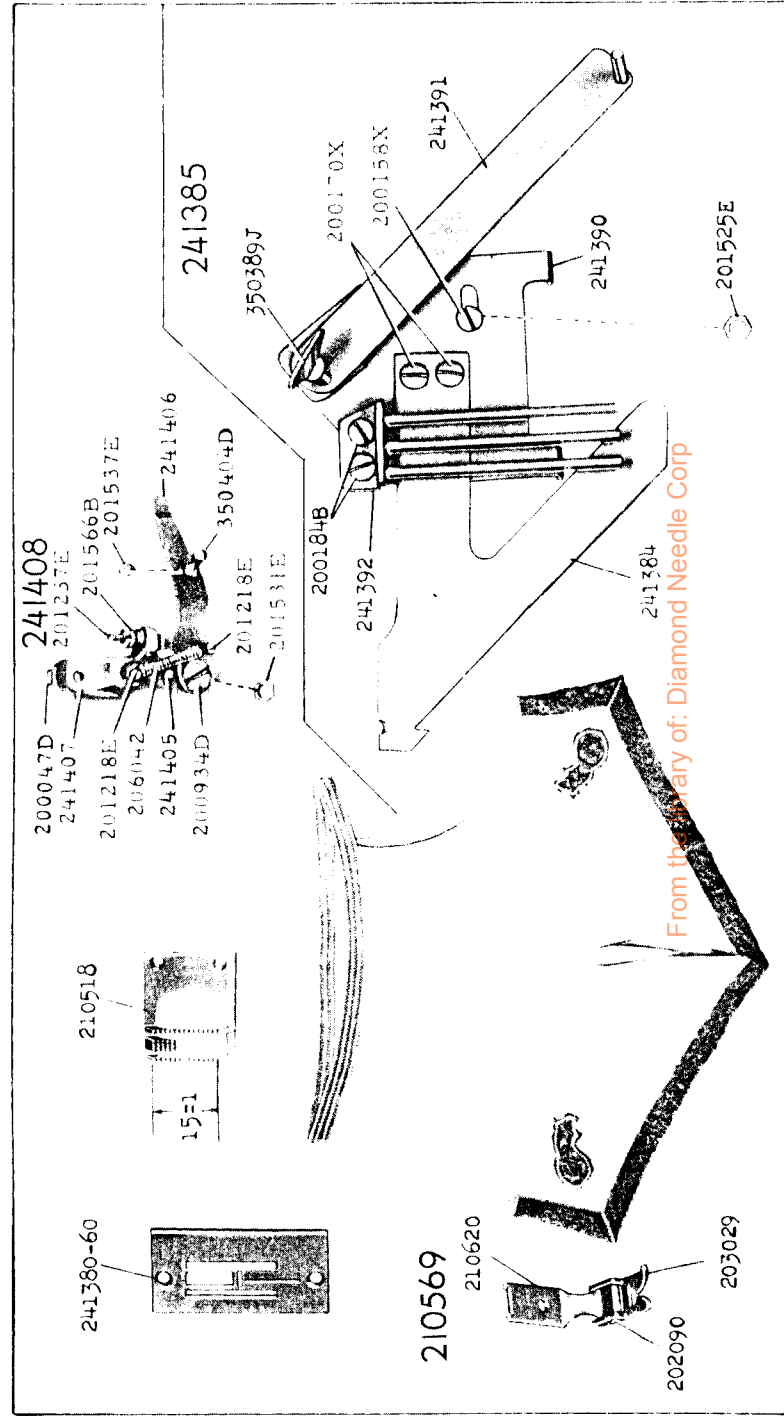

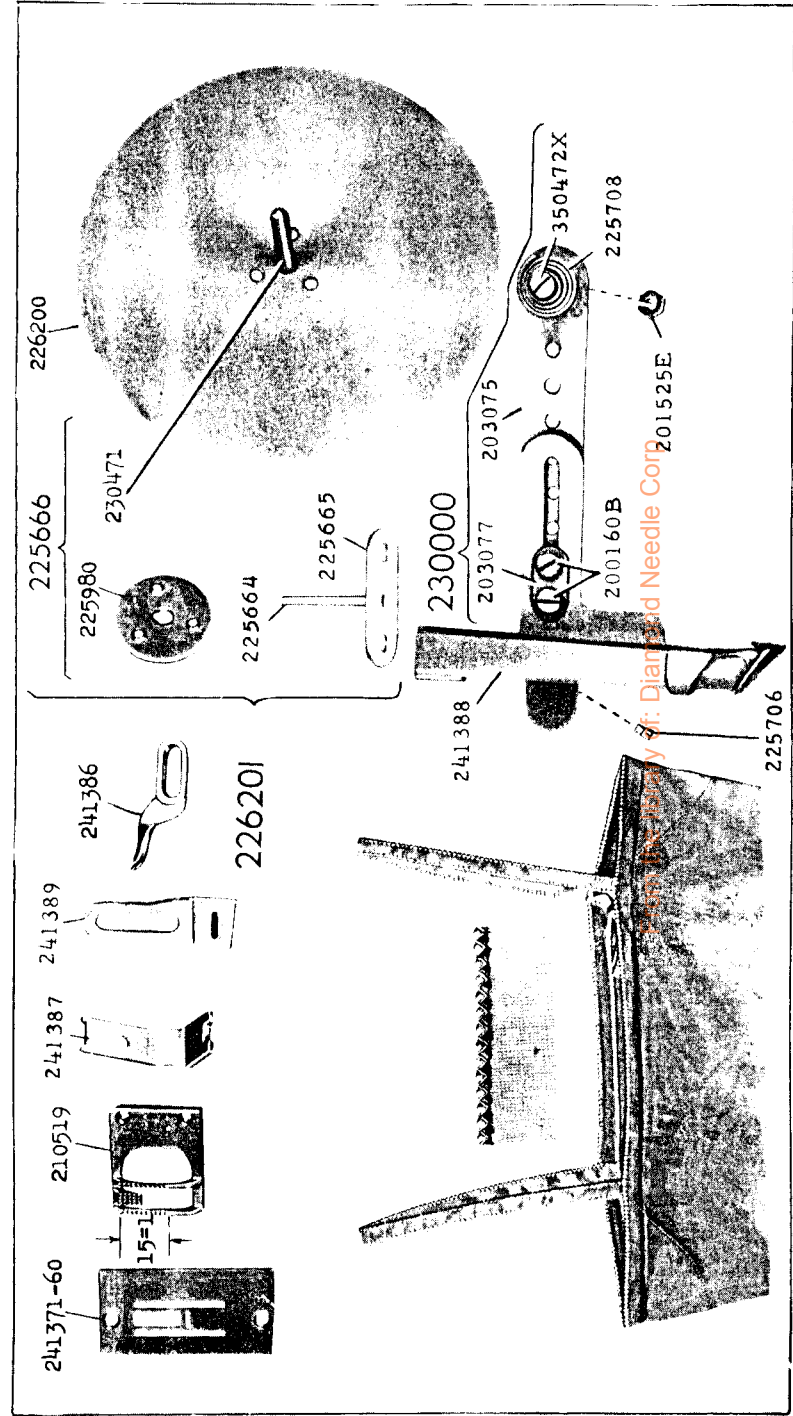
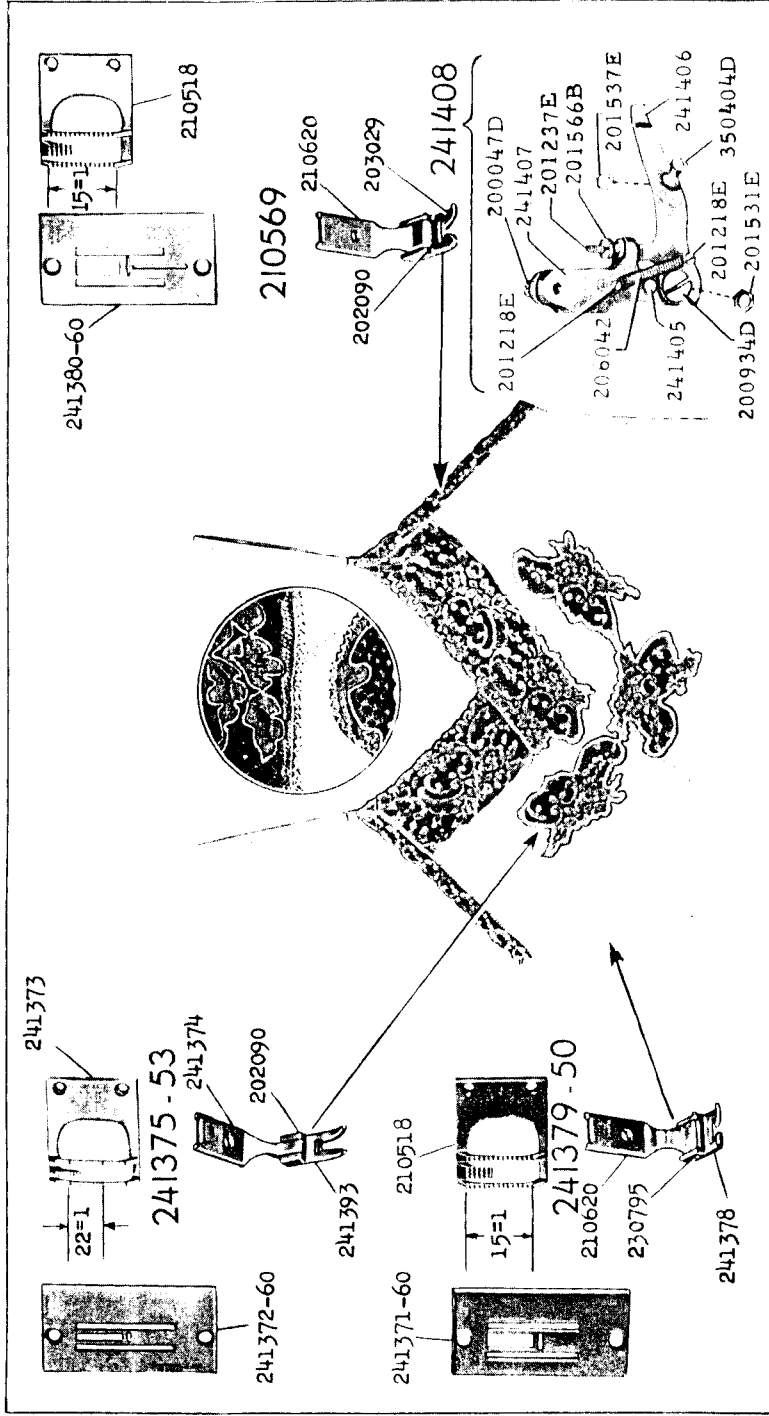

16615 - 1/2

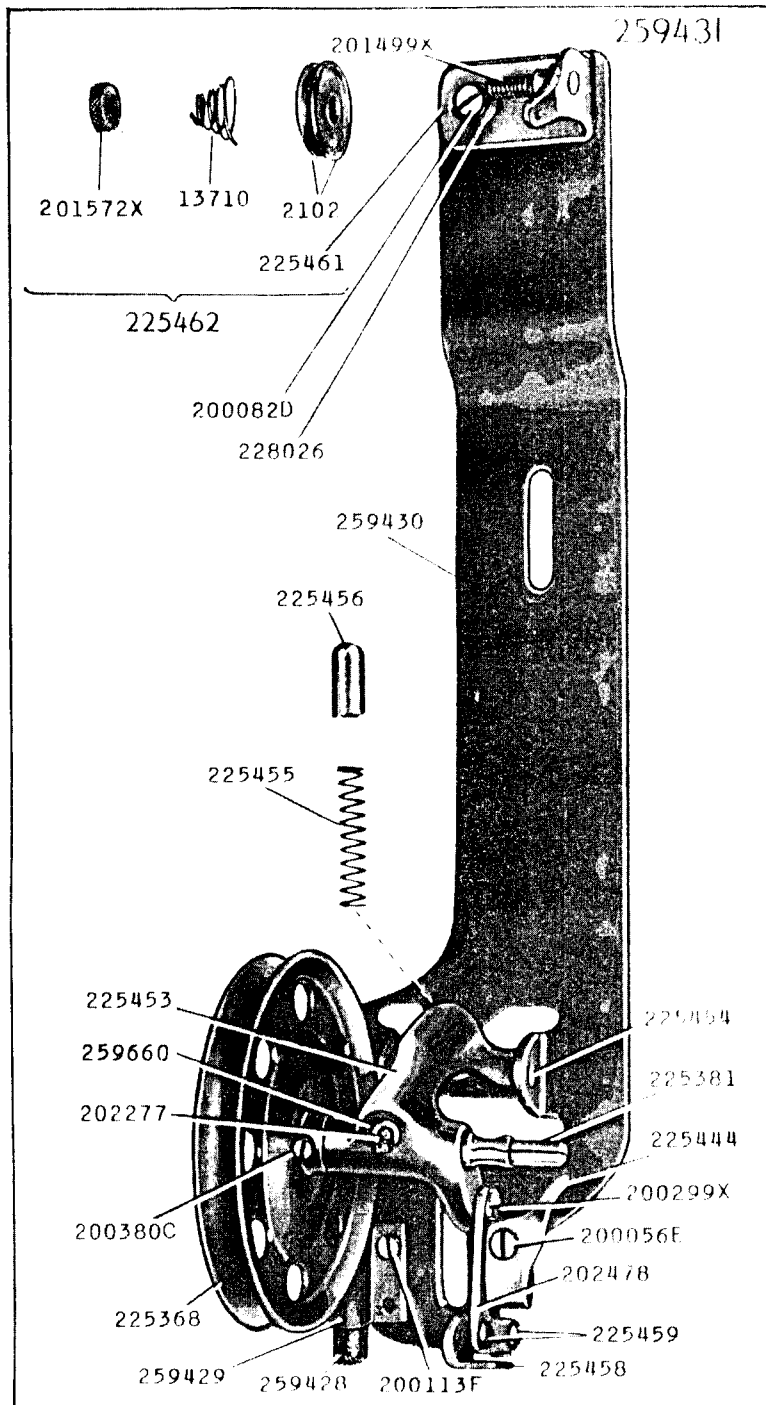

17900 - 1/6

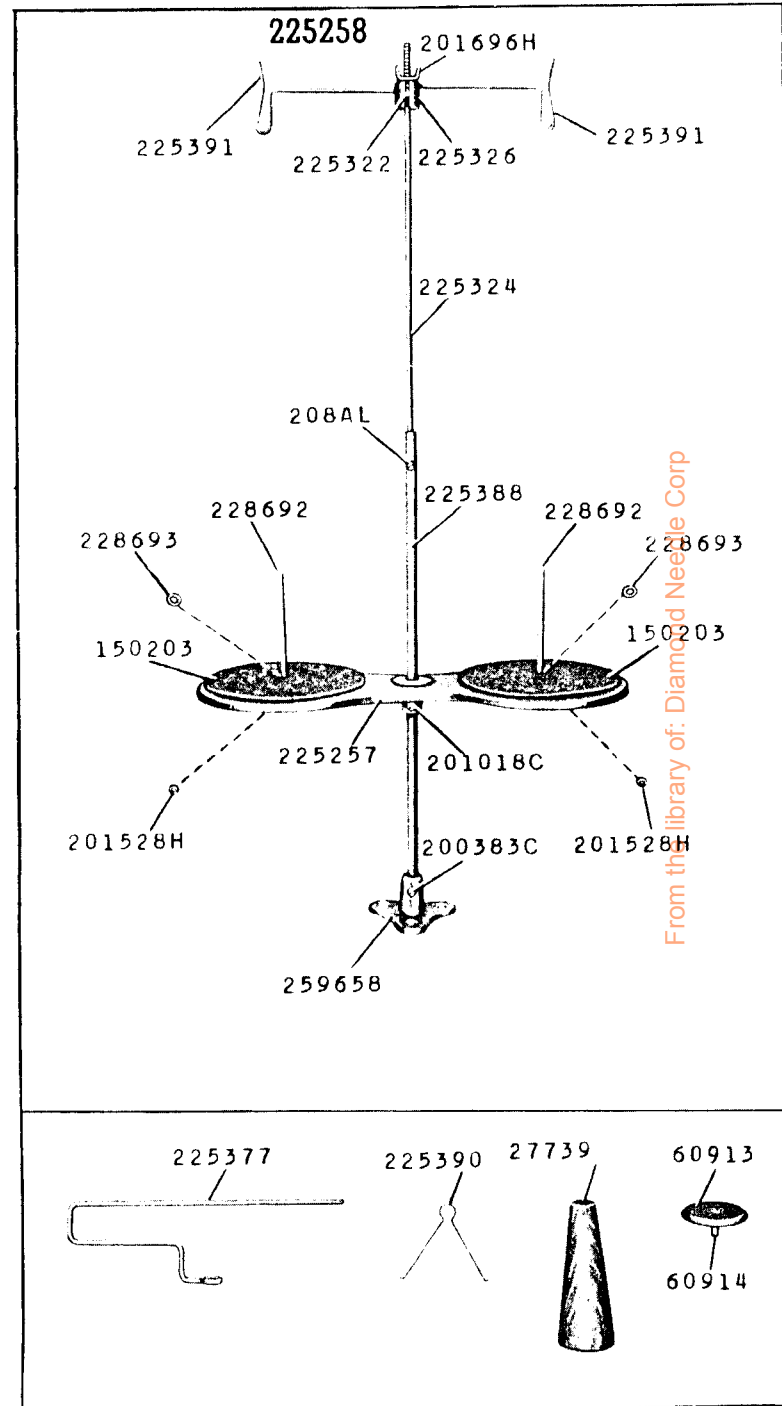

From the library of: Diamond Needle Corp

18580 - 3/8

228710

